

Technical Datasheet



Industrial Series

Diaphragm Operated Pressure Switch

Models: S21, S22 & S24

Key Features

- Weatherproof and Flameproof models ATEX and NEC 500.
- NACE MR-01-75 compatibility.
- Ranges available up to 700 bar (10,000 psi).
Maximum working pressure up to 1000 bar (15,000 psi).
- Field set point adjustment against a reference scale.
- Hermetically sealed microswitch options.
- Optional gold alloy contacts.
- Terminal block for easy field wiring.
- Safety vented design as standard.
- PED 2014/68/EU CAT IV option.



Series Overview

- The Industrial Series switches were developed in the mid -1990's to offer customers a robust range of switches suitable for applications where requirements were more standard than those for which the highly configurable Performance Series switches were designed.
- Using diaphragm based sensors and a more traditional in-line force balance mechanism to transfer movement from the sensor to the microswitch, these switches are suitable for a wide range of industrial applications. Various international approvals make the Industrial Series suitable for use in both safe and Hazardous Areas in Europe, North America and throughout the world.

Other products in the series include:

- Differential Pressure Switches: Model S30
- Temperature Switches: Model S70



Product applications

The S20 Industrial Series is suitable for a wide range of applications in:

- Oil & Gas
- Chemical
- Petrochemical
- Refining
- Power
- OEM

The choice of models available ensures that the S20 Industrial Series is suitable for use in:

- Corrosive atmospheres
- Resistant to chemical attack

How can we help you?

Delta Mobrey offers fast, efficient and knowledgeable support when and where you need it. Please visit our web site at www.delta-mobrey.com to find your local support centre or call us on:

+44 (0)1252 729140

Industrial Series
Models: S21, S22 & S24

How to order

Switches can be configured by selecting codes representing the desired features from the tables that follow. The chart below, describes how the model code is built up. For assistance in configuring a switch that best suits your needs, please contact your local sales office.

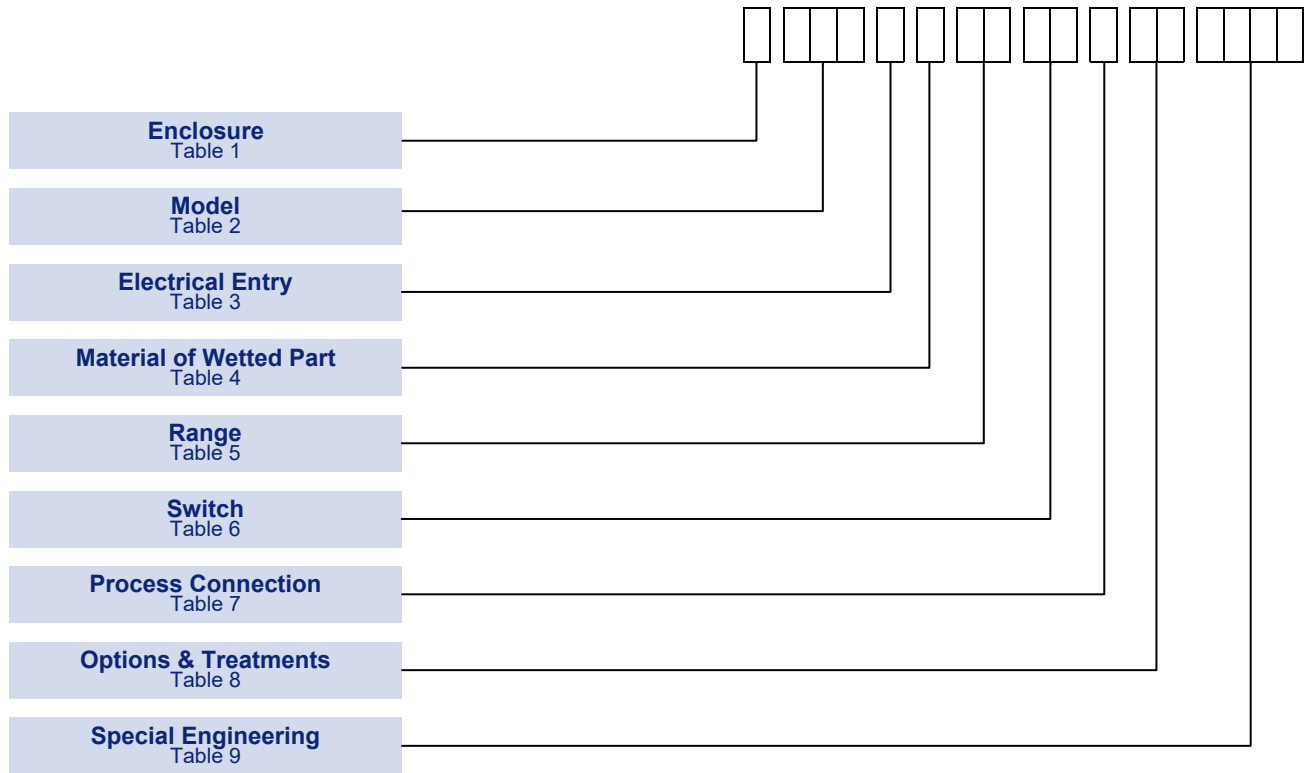

NOTE: Options shaded in the following tables are the most common options and are available on the quickest lead-times and at the lowest cost.

NOTE: Only the most common options are shown in this data sheet. Should you require a feature that is not shown, please contact your local sales office for further details.

Technical Specification

Industrial Series Models: S21, S22 & S24	Accuracy:	Set point repeatability $\pm 1\%$ of span at 20°C / 68°F ambient.
	Storage Temperature:	-25 to +60°C / -13 to +140°F
	Ambient Temperature:	-25 to +60°C / -13 to +140°F For continuous use below -25°C (-13°F) we recommend using only enclosure H, R, T, U & A with special gaskets and limited switching.
	Maximum Process Temperature:	Subject to appropriate installation practice, the component parts withstand up to +60°C (+140°F). For process temperatures up to +120°C (+248°F), order WETTED PARTS Code A (Table 4). For higher temperatures, refer to SPECIAL ENGINEERING.
	Enclosure classification:	IP66 / NEMA 4X / Flameproof Ex d
	Switch output:	SPDT or DPDT snap action microswitch (standard) Hermetically sealed (optional)
	Electrical rating:	See Table 6
	Process Connection:	Rc 1/4 (BSP), 1/4 NPT Internal, 1/2 NPT Internal, 1/2 NPT External
	Approximate Weight:	2.7kg / 5.9lb to 6.6kg / 14.5lb depending on model

Enclosure

TABLE 1

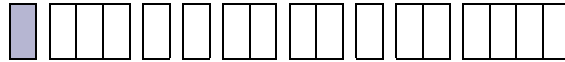

FINISH

All enclosures except Type R, A and U are finished in light grey epoxy resin paint.

Special finishes to order.

INTRINSIC SAFETY

Because of the low voltages and currency of I.S. circuits, we recommend using gold and/or sealed contacts.

NOTE: Codes H, 2 & T for 4X

Aluminium Enclosure protected by quality epoxy paint system.

Performance of enclosure requires careful installation and sealing of cable gland connection in site.

Assembly requires to be built for Marine use, See Table 8, Code 02.

NOTE: Codes 2 and 3









To be used on S24 only with S or T wetted parts.

NOTE: Codes 5 and 4

To be used only on switch codes 04/05, 0G/0H, H2/H3/H6 - See Table 6. PED Cat IV not available at present.

Temperatures in Table 1 refer to limitations for certified enclosures.

See **TECHNICAL DATA**.

ENCLOSURE TYPES	Code
FLAMEPROOF ENCLOSURES	
ATEX Ex d IIC T6 Gb (-60 to +65°C), T5 Gb (-60 to +80°C) II 2 GD (ZONE 1) Gravity die-cast enclosure in aluminium-silicon alloy, epoxy painted. Suitable for outdoor use, IP66 / NEMA 4X.  II 2GD	H
ATEX Ex d IIC T6 Gb (-60 to +65°C), T5 Gb (-60 to +80°C) II 2 GD (ZONE 1) For Aggressive Atmospheres Investment cast enclosure in austenitic stainless steel. Suitable for outdoor use, IP66 / NEMA 4X.  II 2GD	R
ATEX Ex d IIC T6 Ga/Gb (-60 to +65°C), T5 Ga/Gb (-60 to +80°C) (S24 only) IIC 1/2 GD (ZONE 0/1) For Aggressive Atmospheres Investment cast enclosure in austenitic stainless steel. Suitable for outdoor use, IP66 / NEMA 4X.  II 1/2GD	2
ATEX Ex d IIC T6 Ga/Gb (-60 to +65°C), T5 Ga/Gb (-60 to +80°C) (S24 only) II 1/2 GD (ZONE 0/1) Gravity die-cast enclosure in aluminium LM25. Suitable for outdoor use, IP66 / NEMA 4X.  II 1/2GD	3
NEC 500, NEMA 7, 9 Gravity die-cast enclosure in aluminium-silicon alloy, epoxy painted. Class 1, Groups C and D, Class II, Groups E, F and G. Suitable for outdoor use, IP66 / NEMA 4X. 	T
NEC 500, NEMA 7, 9 For Aggressive Atmospheres Investment cast enclosure in austenitic stainless steel. Class 1, Groups C and D, Class II, Groups E, F and G. Suitable for outdoor use, IP66 / NEMA 4X. 	U
WEATHERPROOF ENCLOSURES	
General purpose The basic enclosure is pressure die-cast in zinc alloy, epoxy painted, with weather protection not less than NEMA 4, IP66.	W
For Aggressive Atmospheres Investment cast enclosure in austenitic stainless steel with weather protection not less than NEMA 4X, IP66	A
INTRINSICALLY SAFE ENCLOSURES (ZONE 0)	
ATEX Ex ia IIC T6 Ga (-25°C ≤ Ta ≤ +60°C) or T5 Ga (-60°C ≤ Ta ≤ +80°C) II 1G As code "W" but Ex ia. Weatherproof to IP66 / NEMA 4.  II 1G	5
ATEX Ex ia IIC T6 Ga (-25°C ≤ Ta ≤ +60°C) or T5 Ga (-60°C ≤ Ta ≤ +80°C) II 1G As code "A" but Ex ia. Weatherproof to IP66 / NEMA 4X.  II 1G	4

Models

S21/2

For applications up to 100 bar (1500 psi). Maximum working pressure 155 bar (2250 psi).

S24

For applications up to 700 bar (10,000 psi). Maximum working pressure 1000 bar (15,000 psi)

 Applies only to models S21/ S24

TABLE 2



	Code
Fixed Switching Differential SPDT & DPDT options available. See Table 6.	S21
Adjustable Switching Differential (Limited Span) Achieved by special microswitch with built in adjuster, SPDT only. See Table 6.	S22
Fixed Switching Differential SPDT & DPDT options available. See Table 6.	S24

Electrical Entry

Adaptors are available for other popular thread sizes.

 * For codes 3 & 6 - see approvals and Table 1 Codes T & U.

TABLE 3



	Code
Enclosures W & 5: 22mm (0.86 ins) Dia clearance hole for 20mm / ¾ inch O/Dia Conduit.	1
Enclosures W & 5: M20 x 1.5 elbow adaptor to suit.	0
Enclosure W, A, 5 & 4: 3/4-NPT INT. elbow adaptor to suit.	3
Enclosures H, R, A & 4: M20 x 1.5 ISO thread.	0
Enclosures H & R: M20 x 1.5 ISO thread, dual entry.	5
Enclosures H & R: 1/2-NPT INT. (direct).	2
Enclosures H, R, T & U: 3/4-NPT INT. (direct).	3*
Enclosures H, R, T & U: 3/4-NPT INT. dual entry.	6*
Enclosures W & 5: 22mm (0.86 ins) Dia clearance hole for 20mm / ¾ inch O/Dia Conduit, dual entry.	7
Enclosures H & R: 1/2-NPT INT. dual entry.	4

Material of Wetted Parts

WELDED CONSTRUCTION Codes S and T

For reduced risk against leakage under extreme or unusual conditions the diaphragm may be welded directly to the process connection, eliminating the O-ring.

Welded construction not available on ranges CC to CE (CW to CK). (See table 5).

 Applies to all materials.

TABLE 4



	Code
316 SS diaphragm, process connection and Viton O-ring seal	A
316 SS diaphragm, process connection and Nitrile (Buna-N) O-ring seal	G
Nickel alloy (Monel) diaphragm, 316 SS process connection and Viton O-ring seal for applications as laid down in NACE MR 01-75	K
Nickel alloy (Monel) diaphragm, 316 SS process connection and Nitrile (Buna-N) O-ring seal	P
316 SS diaphragm and process connection. All welded construction	S
Nickel alloy (Monel) diaphragm and process connection. All welded construction (suitable for NACE MR 01-75)	T

Setting Ranges

TABLE 5

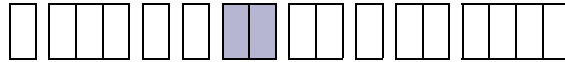

P_{max} = maximum working pressure

When ordering, please state units required. Range and set point will be in units preference.



Applies to all ranges

P_{max}		Model	Range						Code
bar	psi		Bar	mbar	Code	psi	In.Hg	In.H ₂ O	
15	217	S21	-1 to +1.5	12 to 250 -120 to +120 100 to 600 -1000 to 0	CC CD CE A0 G3	1.5 to 8.5 -14.5 to 20	-30 to 0	5 to 100 -50 to +50	CW CH CK AB GK
27	400	S21/2	0.25 to 1.6 0.4 to 2.5 1 to 6		DB DC DE	4 to 25 6 to 40 16 to 100			DK DP DZ
70	1000	S21/2	1.6 to 10 2.5 to 16		EA EB	25 to 160 40 to 250			EH EM
110	1600	S21/2	4 to 25 10 to 40 15 to 75		EC ED EF	60 to 400 160 to 600 250 to 1000			ER EW EE
155	2250	S21/2	10 to 100		FA	160 to 1500			F6

P_{max}		Model	Range			Code
bar	psi		Bar	Code	psi	
-1 to 600	-30 to 8700	S24	0.4 to 2.5 1 to 6	DC DE	6 to 40 16 to 100	DP DZ
			1.6 to 10 2.5 to 16	EA EB	25 to 160 40 to 250	EH EM
			4 to 25 10 to 40 15 to 75	EC ED EF	60 to 400 160 to 600 250 to 1000	ER EW EE
			10 to 100	FA	160 to 1500	F6
1000	15000		7 to 160	U7	100 to 2300	UK
			25 to 250 50 to 400 100 to 700	V7 W7 Y4	350 to 3500 800 to 6000 1600 to 10000	VC W9 YF

Switch Options

TABLE 6

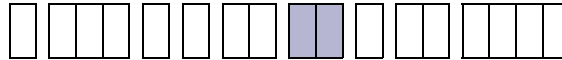

Model S21/4									
CSA RATING (RESISTIVE) § See note	IEC947-5-1 / EN 60947-5-1 RATING							Contact	Code
	Designation & Utilization Category	Rated operational current I_e (A) At rated operational voltage U_e	U_i	U_{imp}	VA Rating				
						Make	Break		
5 Amps @ 110/250V AC Light Duty for AC only	AC14 D300 DC13 R300	0.6/0.3A @ 120/240 V AC 0.22/0.1A @ 125/250V DC	250V	0.8kV	AC DC	432 28	72 28	SPDT DPDT	00 01
5 Amps @ 110/250V AC and 2 Amps @ 30V DC General purpose precision	AC14 D300 DC13 R300	0.6/0.3A @ 120/240 V AC 0.22/0.1A @ 125/250V DC	250V	0.8kV	AC DC	432 28	72 28	SPDT DPDT	02 03
1 Amp @ 125V AC and § 100mA @ 30V DC Gold Alloy contacts for low voltage switching	1A @ 125 VAC RESISTIVE (IEC 1058-1/EN 61058-1)							SPDT DPDT	04 05
§ 5 Amps @ 110/250V AC & 5 Amps @ 30V DC Environmentally sealed	AC14 D300 DC13 R300	0.6/0.3A @ 120/240 V AC 0.22/0.1A @ 125/250V DC	250V	0.5kV	AC DC	432 28	72 28	SPDT* DPDT*	08 09
15 Amps @ 125/250/480V AC General purpose precision	AC14 D300	0.6/0.3A @ 120/240V AC	250V	0.8kV	AC	432	72	SPDT DPDT	10 11
§ 1 Amp @ 30V AC and 30V DC Environmentally sealed with gold contacts	AC14 E150	0.3A @ 120 V AC	125V	0.5kV	AC	216	36	SPDT* DPDT*	0G 0H
5 Amps @ 250V AC & 2 Amps @ 30V DC Hermetically sealed. Gold plated silver contacts	AC14 D300 DC13 R300	0.6/0.3A @ 120/240 V AC 0.22/0.1A @ 125/250V DC	250V	0.5kV	AC DC	432 28	72 28	SPDT DPDT	H2 H3†, H6‡
† 2 Single pole, double throw, simultaneous falling under pressure ‡ 2 Single pole, double throw, simultaneous rising under pressure									
Model S22									
5 Amps @ 110/250V AC Adjustable for AC only	AC14 D300	0.6/0.3A @ 120/240 V AC	250V	0.8kV	AC	432	72	SPDT	0C
5 Amps @ 110/250V AC & 2 Amps @ 30V DC Adjustable	AC14 D300 DC13 R300	0.6/0.3A @ 120/240 V AC 0.22/0.1A @ 125/250V DC	250V	0.8kV	AC DC	432 28	72 28	SPDT	0D
<p>NOTE: Enclosure Codes T and U. Microswitch Codes 02 and 03. CSA rating as follows:- 110/250V AC 5A 250V/125V DC 0.25/0.5A</p> <p>Enclosure Codes H and R. Microswitch Codes 02 and 03. CSA rating as follows:- 110/250V AC 5A 250V/125/30V DC 0.25/0.5/2A</p> <p> 00, 01, 02, 03, 04, 05, H2, H3†, H6‡ microswitches CSA accepted component for use in hazardous areas Class 1, Div 2, Groups A, B, C and D. When used in enclosures T and U.</p> <p>The electrical rating is dependent on the microswitch fitted to the instrument. The electrical ratings defined by each approval that the microswitch complies with and is shown on the product nameplate, ie CSA, or IEC. It should be noted that the instrument must be used within the electrical rating specified from the approval you require. This table lists the actual IEC ratings against the Designation & Utilization Category marked on the nameplates. In the absence of any verification by CSA the microswitch § manufacturer's rating is stated in italics and bold. If in doubt seek guidance from the factory.</p> <p>NOTE: For low energy circuits e.g. 30V and up to 100mA, we recommend using gold alloy contact switches. U_i = rated insulation voltage U_{imp} = rated impulse to withstand voltage across contacts.</p>									

Process Connection

 Applies to all connections in this table.

TABLE 7 

	Code
Rc 1/4 (1/4 BSP tr INT) to (ISO 7/1)	A
1/4—18 NPT INT	F
1/2—14 NPT INT	H
1/2—14 NPT EXT	J

Options & Treatments

Combinations available, apply for details.

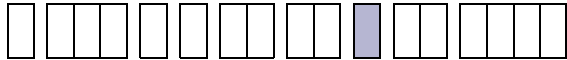
 Applies to all options and treatments in this table.

TABLE 8 

	Code
Tropicalisation High humidity atmospheres	01
Marine and Offshore Saline atmosphere or salt spray	02
Ammonia Process (wetted) parts and construction suitable for atmospheric ammonia	03
Oxygen Service 2: Process (wetted) parts are cleaned for oxygen	04
Oxygen Service 3: Process and non-process parts are cleaned for use with oxygen	05
Stainless Steel Pipe Mounting Bracket Permits local 2" pipe work to be utilized for mounting the instrument	10
Category IV Safety Accessory as defined in the Pressure Equipment Directive 2014/68/EU	60
Tagging - Variety of tagging methods are available	APPLY FOR DETAILS
Applies when - no option is required and selection is made from special engineering	00

Special Engineering

Last 4 digits of model code only used when special engineering is required.

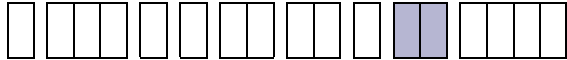

 Refer to engineering

TABLE 9 

	Code
Please consult Delta sales engineering for special requirements	TBA

Performance Data

TABLE 10

TABLES 10A, 10B MODEL S21 FIXED SWITCHING DIFFERENTIAL

Due to manufacturing tolerances the figures quoted in these tables are for guidance only.

Should the differential be critical for specific applications our engineers should be consulted prior to ordering.

MODEL S21 PSI UNITS TABLE 10A

Range		P _{max} psi	SWITCHING OPTIONS SWITCHING DIFFERENTIAL IN H ₂ O / in Hg / psi									
Code	H ₂ O / in Hg / psi		00	01	02	03	04	05	08/0G	09/0H	H2	H3/H6
CW	5 to 100	217	2.0	3.2	2.4	3.2	2.0	2.4	3.2	6.0	12.0	12.0
CH	-50 to +50	217	3.2	5.6	3.2	9.2	3.2	3.2	5.6	7.2	8.0	8.0
CK	1.5 to 8.5	217	3.2	5.6	6.0	9.2	3.2	4.8	5.6	7.2	18.0	18.0
AB	-30 to 0	217	0.6	0.8	1.3	1.7	0.5	0.5	0.8	1.0	3.0	3.0
GK	14.5 to +20	218	0.3	0.6	0.7	1.5	0.3	0.4	0.5	0.7	2.2	2.2
DK	4 to 25	400	0.4	0.7	1.0	1.5	1.0	1.5	2.6	3.5	1.2	2.3
DP	6 to 40	400	0.4	0.7	1.0	1.5	1.0	1.5	2.6	3.5	1.2	2.3
DZ	16 to 100	400	0.6	0.9	1.7	2.0	1.5	2.2	3.5	1.6	2.9	5.8
EH	25 to 160	1000	1.5	2.2	3.6	6.5	2.2	3.3	11.6	14.5	6.0	11.6
EM	40 to 250	1000	2.2	4.0	5.1	9.9	3.6	5.8	13.1	17.4	7.5	14.5
ER	60 to 400	1600	4.4	6.5	15.2	19.6	7.3	10.2	26.0	35.0	26.0	52.0
EW	160 to 600	1600	7.3	11.6	20.0	26.0	11.6	17.4	44.0	46.0	31.0	61.0
EE	250 to 1000	1600	9.4	14.5	25.0	33.0	14.5	22.0	44.0	58.0	51.0	102
F6	160 to 1500	2250	14.5	22.0	51.0	65.0	29.0	44.0	87.0	116	73.0	145

MODEL S21 BAR UNITS TABLE 10B

Range		P _{max} bar	SWITCHING OPTIONS SWITCHING DIFFERENTIAL IN mbar									
Code	mbar/bar		00	01	02	03	04	05	08/0G	09/0H	H2	H3/H6
CC	12 to 250	15	5	8	6	8	5	6	8	15	30	30
CD	-120 to +120	15	8	14	8	23	8	8	14	18	20	20
CE	100 to 600	15	8	14	15	23	8	12	14	18	45	45
A0	-1000 to 0	15	21	27	45	60	18	18	30	36	105	105
G3	-1 to +1.5	15	21	40	48	100	24	30	36	45	150	150
DB	0.25 to 1.6	27	30	45	70	100	70	100	180	240	80	160
DC	0.4 to 2.5	27	30	45	70	100	70	100	180	240	80	160
DE	1 to 6	27	40	60	120	140	100	150	240	320	200	400
EA	1.6 to 10	70	100	150	250	450	150	230	800	1000	400	800
EB	2.5 to 16	70	150	275	350	680	250	400	900	1200	500	1000
EC	4 to 25	110	300	450	1050	1350	500	700	1800	2400	1800	3600
ED	10 to 40	110	500	800	1400	1800	800	1200	3000	3200	2100	4200
EF	15 to 75	110	650	1000	1750	2250	1000	1500	3000	4000	3500	7000
FA	10 to 100	155	1000	1500	3500	4500	2000	3000	6000	8000	5000	10000

Performance Data

TABLE 10

TABLES 10C, 10D MODEL S24 FIXED SWITCHING DIFFERENTIAL

Due to manufacturing tolerances the figures quoted in these tables are for guidance only.

Flameproof models maybe up to 2 times higher depending on the range.

Should the differential be critical for specific applications, our engineers should be consulted prior to ordering.

MODEL S24

PSI UNITS

TABLE 10C

Range		P _{max} psi	SWITCHING OPTIONS SWITCHING DIFFERENTIAL IN psi									
Code	psi		00	01	02	03	04	05	08/0G	09/0H	H2	H3/H6
DP	6 to 40	8700	3.2	4.8	5.8	5.8	4.4	4.4	6.5	7.4	6.0	11.6
DZ	16 to 100	8700	3.5	5.8	8.7	11.6	7.3	10.2	8.7	9.4	12.0	23.0
EH	25 to 160	8700	5.5	10.2	11.6	17.4	8.7	13.0	8.7	11.0	18.0	35.0
EM	40 to 250	8700	6.7	11.5	11.6	17.4	8.7	13.0	11.6	17.4	18.0	35.0
ER	60 to 400	8700	12.5	20.0	17.4	23.0	11.6	17.4	20.0	22.0	34.0	67.0
EW	160 to 600	8700	14.5	23.0	29.0	44.0	22.0	36.0	29.0	44.0	51.0	102
EE	250 to 1000	8700	22.0	28.0	36.0	73.0	22.0	58.0	44.0	58.0	58.0	116
F6	160 to 1500	8700	29.0	36.0	65.0	87.0	51.0	73.0	58.0	73.0	73.0	145
UK	100 to 2300	15000	49.0	80.0	99.0	145	58.0	77.0	73.0	90.0	150	290
VC	350 to 3500	15000	81.0	162	145	244	122	203	725	870	370	725
W9	800 to 6000	15000	128	255	255	574	192	319	1160	1160	600	1160
YF	1600 to 10000	15000	218	435	290	653	326	486	1450	1450	750	1450

MODEL S24

BAR UNITS

TABLE 10D

Range		P _{max} bar	SWITCHING OPTIONS SWITCHING DIFFERENTIAL IN mbar									
Code	bar		00	01	02	03	04	05	08/0G	09/0H	H2	H3/H6
DC	0.4 to 2.5	600	220	330	400	400	300	300	450	510	400	800
DE	1 to 6	600	240	400	600	800	500	700	600	650	800	1600
EA	1.6 to 10	600	380	700	800	1200	600	900	600	750	1200	2400
EB	2.5 to 16	600	480	790	800	1200	600	900	800	1200	1200	2400
EC	4 to 25	600	860	1400	1200	1600	800	1200	1350	1500	2300	4600
ED	10 to 40	600	1000	1600	2000	3000	1500	2500	2000	3000	3500	7000
EF	15 to 75	600	1500	1900	2500	5000	1500	4000	3000	4000	4000	8000
FA	10 to 100	600	2000	2500	4500	6000	3500	5000	4000	5000	5000	10000
U7	7 to 160	1000	3400	5500	6800	10000	4000	5300	5000	6200	10000	20000
V7	25 to 250	1000	5600	11200	10000	16800	8400	14000	50000	60000	35000	50000
W7	50 to 400	1000	8800	17600	17600	39600	13200	22000	80000	80000	40000	80000
Y4	100 to 700	1000	15000	30000	20000	45000	22500	33500	100000	100000	50000	100000

Performance Data

TABLES 10E, 10F MODEL S22 ADJUSTABLE SWITCHING DIFFERENTIAL

Due to manufacturing tolerances the figures quoted in these tables are for guidance only.

Flameproof models maybe up to 2 times higher depending on the range.

Should the differential be critical for specific applications, our engineers should be consulted prior to ordering.

TABLE 10

MODEL S22		PSI UNITS		TABLE 10E				
Range		P _{max} psi	SWITCHING OPTIONS SWITCHING DIFFERENTIAL psi					
Code	psi		MIN	0C	MAX	MIN	0D	MAX
DK	4 to 25	400	0.2		1.1	1.0		2.9
DP	6 to 40	400	0.3		1.2	1.3		3.0
DZ	16 to 100	400	0.5		2.8	2.5		7.3
EH	25 to 160	1000	1.9		6.2	6.4		16.0
EM	40 to 250	1000	3.2		9.1	9.6		23.0
ER	60 to 400	1600	9.6		35.0	41.0		88.0
EW	160 to 600	1600	13.0		61.0	57.0		125
EE	250 to 1000	1600	16.0		62.0	80.0		160
F6	160 to 1500	2250	25.0		83.0	96.0		212

MODEL S22		BAR UNITS		TABLE 10F				
Range		P _{max} bar	SWITCHING OPTIONS SWITCHING DIFFERENTIAL mbar					
Code	bar		MIN	0C	MAX	MIN	0D	MAX
DB	0.25 to 1.6	27	11		78	66		200
DC	0.4 to 2.5	27	22		82	88		210
DE	1 to 6	27	33		190	170		500
EA	1.6 to 10	70	132		430	440		1100
EB	2.5 to 16	70	220		630	660		1600
EC	4 to 25	110	660		2400	2800		6100
ED	10 to 40	110	880		3300	3900		8600
EF	15 to 75	110	1100		4300	5500		11000
FA	10 to 100	155	1700		5700	6600		14600

Electrical Connections

Terminal Block

Cable entry is to a non-pinching terminal block made of a non-hygroscopic thermosetting plastic, suitable for cables up to 2.5mm²/14AWG.

Earthing/Grounding

An earthing stud is provided inside all weatherproof enclosures, adjacent to the entry. External earthing is standard on flameproof versions. Safety note see Table 3.

Dielectric Strength

The electrical assembly is capable of withstanding *2kV between live parts and earth/ground and 500V between open contacts.

* 1.2kV for micro switch Codes H2, H3, and H6. Refer to Table 6.

Electrical Entry

Standard options are listed in Table 3. Other threads can be accommodated by adaptors. Dual entry available, see Table 3.

Optional Extras

Chemical Seals

Chemical seals of our own or proprietary manufacture can be fitted when required.

Mounting Position/Location/Installation

Vertical as shown, IN DIMENSIONS, taking care to avoid siting in locations that transmit excessive shock or vibration. For further advice contact our engineers.

Pollution degree (EN60947-5-1)

All products are suitable for use in pollution degree 3. For extreme conditions where condensation may readily form, then sealed contacts should be used. See Table 6 Codes 08/09, 0G/0H, H2/H3/H6.

Electrical Isolation

These products are not suitable for electrical isolation. Always isolate circuit separately to carry out any electrical work.

Approvals

EUROPEAN DIRECTIVES



Low voltage Directive (LVD) 2014/35/EU.
Compliant to LVD

Pressure Equipment Directive (PED) 2014/68/EU:
This product has a process connection size \leq DN25 and is therefore categorised as sound engineering practice under Cat 3.3

ATEX Directive 2014/34/EU



INTRINSIC SAFETY:
Certificate No. Baseefa05ATEX0111
EN 60079-0, EN 60079-11

For Zone 0 models (**Enclosure code 4/5, see table 1**)

Because of the low voltages and currents of intrinsically safe circuits, we recommend using gold contacts.
Refer to Table 6.

II 1 G Ex ia IIC T6 Ga (Tamb -25°C to $+60^{\circ}\text{C}$) or T5 Ga (Tamb -60°C to $+80^{\circ}\text{C}$)

FLAMEPROOF:
Certificate No. BAS01ATEX2113X
EN 60079-0, EN 60079-1, EN 60079-31, EN 60079-26

For Zone 0/1 models (**Enclosure code 2/3, see table 1**)

Fluorosilicone O-ring

II 1/2 GD Ex d IIC T6 Ga/Gb (Tamb -60°C to $+65^{\circ}\text{C}$)
Ex ta/tb IIIC T85 $^{\circ}\text{C}$ Da/Db

II 1/2 GD Ex d IIC T5 Ga/Gb (Tamb -60°C to $+80^{\circ}\text{C}$)
Ex ta/tb IIIC T100 $^{\circ}\text{C}$ Da/Db

Nitrile O-ring

II 1/2 GD Ex d IIC T6 Ga/Gb (Tamb -30°C to $+65^{\circ}\text{C}$)
Ex ta/tb IIIC T85 $^{\circ}\text{C}$ Da/Db

II 1/2 GD Ex d IIC T5 Ga/Gb (Tamb -30°C to $+80^{\circ}\text{C}$)
Ex ta/tb IIIC T100 $^{\circ}\text{C}$ Da/Db

For Zone 1 models (**Enclosure code H/R, see table 1**)

Fluorosilicone O-ring

II 2 GD Ex d IIC T6 Gb (Tamb -60°C to $+65^{\circ}\text{C}$)
Ex tb IIIC T85 $^{\circ}\text{C}$ Db

II 2 GD Ex d IIC T5 Gb (Tamb -60°C to $+80^{\circ}\text{C}$)
Ex tb IIIC T100 $^{\circ}\text{C}$ Db

Nitrile O-ring

II 2 GD Ex d IIC T6 Gb (Tamb -30°C to $+65^{\circ}\text{C}$)
Ex tb IIIC T85 $^{\circ}\text{C}$ Db

II 2 GD Ex d IIC T5 Gb (Tamb -30°C to $+80^{\circ}\text{C}$)
Ex tb IIIC T100 $^{\circ}\text{C}$ Db

GLOBAL CERTIFICATION



CANADIAN STANDARDS ASSOCIATION
Switches - Automatic - Pressure Type - for hazardous locations
Enclosure codes T & U.
Class 1, Groups C & D Class II, Groups E, F, G.
LR94185-2

SAFETY INTEGRITY LEVEL (SIL)
IEC 61508 Part 1 and 2
Systematic integrity and random integrity SIL2 Capable
Certificate number DC060816C001

Dimensions

All dimensions mm (inches)

H, R, T & U ENCLOSURES

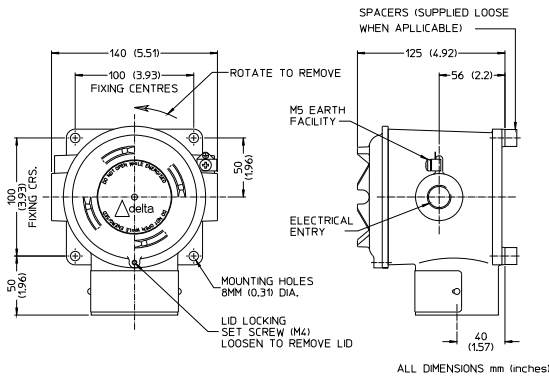

W/5 ENCLOSURE

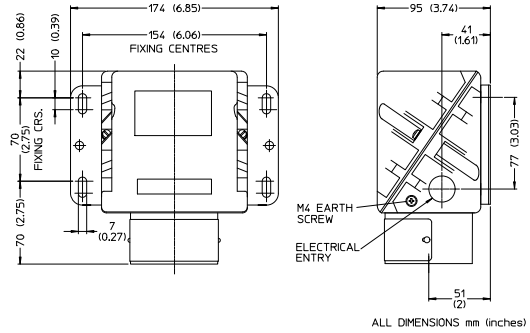

A/4 ENCLOSURE

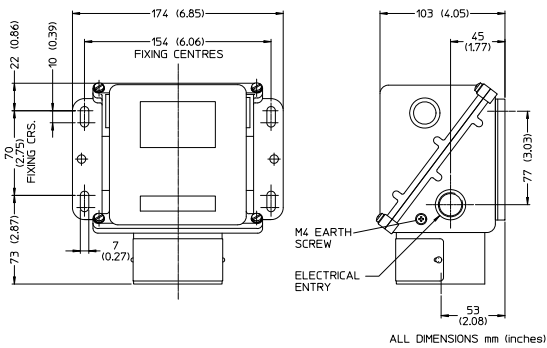

MODEL S21/2 ALL RANGES EXCEPT CC, CD & CE

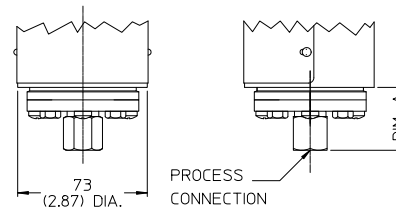

PROCESS CONN.	DIM 'A'
Rc1/4	36 (1.41)
1/4"NPT INT.	
1/2"NPT INT.	48 (1.88)
1/2"NPT EXT.	

ALL DIMENSIONS mm (inches)

MODEL S21/2 RANGES CC, CD & CE

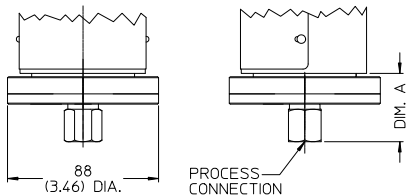

PROCESS CONN.	DIM. A
Rc1/4	40 (1.57)
1/4"NPT INT.	
1/2"NPT INT.	52 (2.04)
1/2"NPT EXT.	

ALL DIMENSIONS mm (inches)

MODEL S24 ALL RANGES

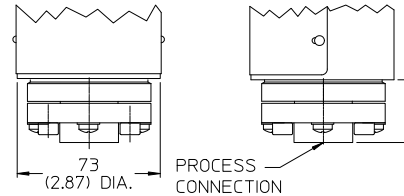

PROCESS CONN.	DIM. A
Rc1/4	33 (1.29)
1/4"NPT INT.	
1/2"NPT INT.	45 (1.77)
1/2"NPT EXT.	60 (2.36)

ALL DIMENSIONS mm (inches)

CABLE GLAND ASSEMBLY

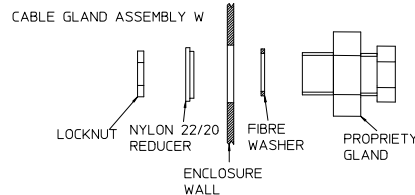

Industrial Series
Models: S21, S22 & S24

In the interest of development and improvement Delta Mobrey Ltd, reserves the right to amend, without notice, details contained in this publication. No legal liability will be accepted by Delta Mobrey Ltd for any errors, omissions or amendments.

Delta Mobrey Limited
Riverside Business Park, Dogflud Way, Farnham, Surrey GU9 7SS, UK.
T+44 (0)1252 729140 F+44 (0)1252 729168 E sales@delta-mobrey.com W www.delta-mobrey.com



FM00720
Page 12 of 12